



ENGLISH

DEUTSCH

snom m3

User Guide SHORT VERSION

Bedienungsanleitung KURZVERSION

User Guide SHORT VERSION
Bedienungsanleitung KURZVERSION

Version 1.31

© 2007 snom technology AG

All rights reserved.
Alle Rechte vorbehalten.

For questions regarding the product,
please contact your snom Value Added Reseller (VAR).
Bei Fragen bezüglich des Produkts kontaktieren Sie bitte
Ihren snom Fachhändler.

Also visit us at **www.snom.com**
Besuchen Sie uns auf **www.snom.com**

WELCOME

Thank you for purchasing the **snom m3**. This user guide describes how to install, configure, and use the **snom m3**, enabling you to make SIP calls.

About this User Manual

This user guide consists of a number of sections to guide you through the process of installing, configuring, and setting up your phone for first use. These sections are best read from beginning to end. The remaining sections of this user guide serve as a reference guide for all features of the **snom m3**. In this manual we have used the following abbreviations:

DHCP	– Dynamic Host Configuration Protocol
IP	– Internet Protocol
LAN	– Local-Area Network
NAT	– Network Address Translation
SIP	– Session Initiation Protocol
STUN	– Simple Traversal of UDP through NAT
URL	– Uniform Resource Locator
NET	– Network

For more information see the glossary on our website. On the website you can also find additional information about the **snom m3** such as troubleshooting, frequently asked questions and support contact information.

www.snom.com

Have your serial number and MAC address ready when contacting support. You find the numbers on the bottom of the gateway. For inquiries concerning your network connection contact your network administrator.

For the EU: The telephone's conformity with EU directives is confirmed by the CE symbol. We hereby declare that the snom m3 and the snom m3 handset are in compliance with the essential requirements and other relevant provisions of Directive 1999/5/EC.

This device complies with Part 15 of the FCC Rules. Operation is subject to the following two conditions: (1) this device may not cause harmful interference, and (2) this device must accept any interference received, including interference that may cause undesired operation.

NOTE: This equipment has been tested and found to comply with the limits for a Class B digital device, pursuant to Part 15 of the FCC Rules. These limits are designed to provide reasonable protection against harmful interference in a residential installation. This equipment generates, uses and can radiate radio frequency energy and, if not installed and used in accordance with the instructions, may cause harmful interference to radio communications. However, there is no guarantee that interference will not occur in a particular installation. If this equipment does cause harmful interference to radio or television reception, which can be determined by turning the equipment off and on, the user is encouraged to try to correct the interference by one or more of the following measures:

- Reorient or relocate the receiving antenna.
- Increase the separation between the equipment and receiver.
- Connect the equipment into an outlet on a circuit different from that to which the receiver is connected.
- Consult the dealer or an experienced radio/TV technician for help.

Modifications not expressly approved could void the user's authority to operate the equipment.

Privacy of communications may not be ensured when using this equipment.

This handset meets the FCC standard for Hearing Aid Compatibility.

Important safety information

Do not install the handset, handset charger, AC/DC adapter, gateway, power cord, and network cord outdoors. **NOT FOR OUTDOOR USE!**

Charge the battery or handset only in combination with snom m3 DECT Handset Desktop Charger and the SALOM SSW-1444 adapter that comes with the product. Plug the SALOM SSW-1444 AC/DC adapter in a wall outlet socket near the equipment for easy access/removal of the AC/DC adapter. Use only power adapter Sino American model A31230A/G/B or SALOM SSW-1187US which comes with the product to connect with snom m3 Gateway.

Important battery information

This product uses rechargeable Lithium-Ion batteries 3.7V, 650mAh. Only

use batteries with "snom" brand and P/N: 60020438 or 60020438 that come with the handset or dedicated spare batteries recommended by snom technology AG. Do not use any other type, since this may present a risk of leakage, fire, explosion or other hazardous situation. For battery replacement or removal please remove the battery cover of the handset. Never disassemble, customize or short-circuit batteries. Do not place battery in fire or heat the battery. Charge battery only within the snom m3 handset together with snom m3 Charger and the SALOM SSW-1444 adapter that comes with the product.

Charging and discharging

Your device is powered by a rechargeable battery. The full performance of a new battery is achieved only after two or three complete charge and discharge cycles.

The battery can be charged and discharged hundreds of times, but it will eventually wear out. Use only snom technology AG approved batteries. If left unused, a fully charged battery will lose its charge over time. If the battery is completely discharged, it may take a few minutes before the charging indicator appears on the display.

Use the battery only for its intended purpose. Never use any charger or battery that is damaged. Do not short-circuit the battery. Short-circuiting the terminals may damage the battery or the connecting object.

Leaving the battery in hot or cold places will reduce the capacity and lifetime of the battery. Charge batteries within an ambient temperature range of 0° C to 40° C (32° F to 104° F). A device with a hot or cold battery may not work temporarily, even when the battery is fully charged.

Avoid overcharging, repeated overcharging can lead to deterioration in battery performance. Never attempt reverse charging, charging with polarity reversed can cause a reversal in battery polarity causing gas pressure inside the battery to rise, which can activate the safety vent, lead to leakage. Storage temperature and humidity (short-term): Store batteries in a dry location with low humidity, no corrosive gases, and at a temperature range of -20° C to 45° C (-4° F to 113° F). Long-term storage: Store at a temperature ranges between +10° C and +30° C (50° F to 86° F).

Sensitive Electronic Environment

Any radio-based equipment can potentially cause interference with other equipment and can be interfered from other equipment. This also applies for DECT equipment. However due to the very low transmission power level the chances for interference are very small. Research proves that operational DECT phones normally don't influence electronic equipment however some precautions must be taken into account for sensitive electronic equipment e.g. sensitive laboratory equipment. When DECT phones operate in straight nearness of sensitive electronic equipment incidental influence can appear. You are advised not to place the DECT phone on or close (less than 10 cm) to this kind of equipment, even in standby mode.

Additional safety information

Small children:

Your device and its enhancements may contain small parts. Keep them out of the reach of small children.

Operating environment:

Remember to follow any special regulations in force in any area, and always

switch off your device when its use is prohibited or when it may cause interference or danger. Use the device only in its normal operating positions. Do not place credit cards or other magnetic storage media near the device, because information stored on them may be erased.

Medical devices

Operation of any radio transmitting equipment, may interfere with the functionality of inadequately protected medical devices. Consult a physician or the manufacturer of the medical device to determine if they are adequately shielded from external RF energy or if you have any questions. Switch off your device in health care facilities when any regulations posted in these areas instruct you to do so. Hospitals or health care facilities may be using equipment that could be sensitive to external RF energy.

Implanted medical devices

Manufacturers of medical devices recommend that a minimum separation of 15.3 centimeters (6 inches) should be maintained between a wireless device and an implanted medical device, such as a pacemaker or implanted cardioverter defibrillator, to avoid potential interference with the medical device. Persons who have such devices should: Always keep the wireless device more than 15.3 centimeters (6 inches) from the medical device when the wireless device is turned on.

- Not carry the wireless device in a breast pocket.
- Hold the wireless device to the ear opposite the medical device to minimize the potential for interference.
- Turn the wireless device off immediately if there is any reason to suspect that interference is taking place.
- Read and follow the directions from the manufacturer of their implanted medical device.

If you have any questions about using your wireless device with an implanted medical device, consult your health care provider.

Potentially explosive environments

Switch off your device when in any area with a potentially explosive atmosphere and obey all signs and instructions. Sparks in such areas could cause an explosion or fire resulting in bodily injury or even death. Switch off the device at refuelling points such as near gas pumps at service stations. Observe restrictions on the use of radio equipment in fuel depots, storage, and distribution areas; chemical plants; or where blasting operations are in progress. Areas with a potentially explosive atmosphere are often but not always clearly marked. They include below deck on boats, chemical transfer or storage facilities, vehicles using liquefied petroleum gas, and areas where the air contains chemicals or particles such as grain, dust, or metal powders.

Product disposal information



For countries in the European Union:

The symbol depicted here has been affixed to your product in order to inform you that electrical and electronic products should not be disposed of as municipal waste. Electrical and electronic products

including the cables, plugs and accessories should be disposed of separately in order to allow proper treatment, recovery and recycling. These products should be taken to a designated facility where the best available treatment, recovery and recycling techniques are available. Separate disposal has significant advantages: valuable materials can be re-used and it prevents the dispersion of unwanted substances into the municipal waste stream. This contributes to the protection of human health and the environment. Please be informed that a fine may be imposed for illegal disposal of electrical and electronic products via the general municipal waste stream. In order to facilitate separate disposal and environmentally sound recycling, arrangements have been made for local collection and recycling. In case your electrical and electronic products need to be disposed of please refer to your supplier or the contractual agreements that your company has made upon acquisition of these products.

For countries outside the European Union:

Disposal of electrical and electronic products in countries outside the European Union should be done in line with the local regulations. Please contact the local authorities for further information.

Battery disposal information:

Defect or exhausted batteries should never be disposed of as municipal waste. Return old batteries to the battery supplier, a licensed battery dealer or a designated collection facility. Do not incinerate batteries.

It is recommended that the customer install an AC surge arrester in the AC outlet to which this device is connected. This is to avoid damage to the equipment caused by local strikes of lightning and other electrical surges.

SELV (Safety Extra Low Voltage) Compliance

Safety status of Input/Output connections comply to SELV requirements.

Warning: To avoid electric shock, do not connect safety extra-low voltage (SELV) circuits to telephone-network voltage (TNV) circuits. LAN ports contain SELV circuits, and PSTN ports contain TNV circuits. Some LAN and PSTN ports both use RJ-45 (8P8C) connectors. Use caution when connecting cables.

snom technology AG reserves the right to revise this document and make changes at any time and without the obligation to notify any person and/or entity of such revisions and/or changes.

Product specifications contained in this document are subject to change without notice.

AT A GLANCE

Handset – front view

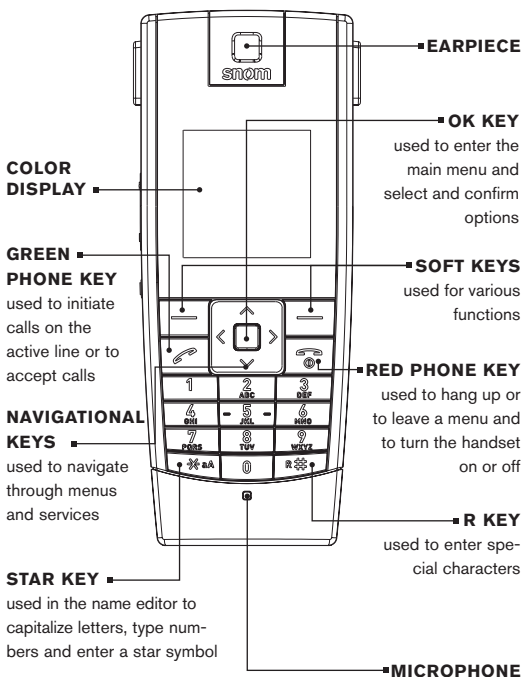

Handset – side view

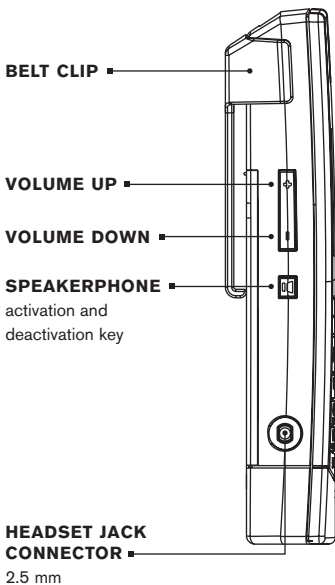

Handset Charger – front view

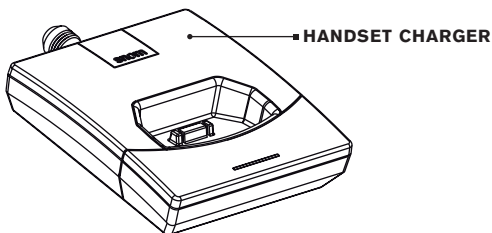

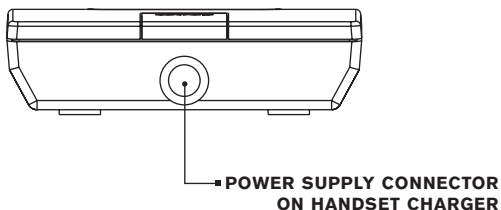

Handset Charger – rear view

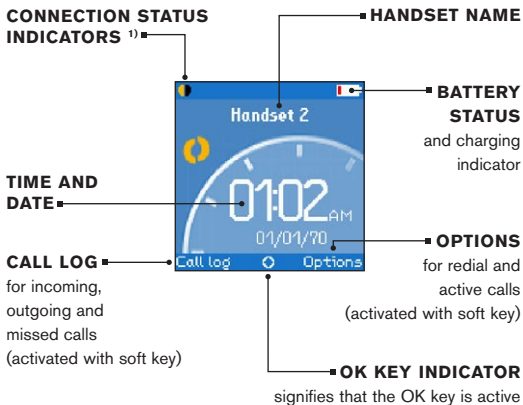

Idle mode



1)

-  black / black – out of range of the gateway
-  yellow / black – within range of the gateway, but not ready for SIP calls
-  yellow / yellow – within range of the gateway and ready for SIP calls on primary line

Main menu

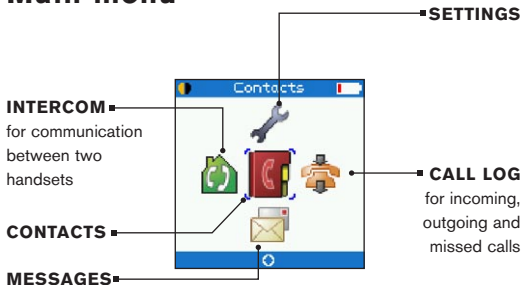

Gateway – rear view

POWER CONNECTION

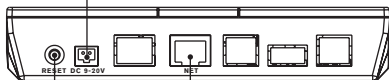

RESET-BUTTON

for activating configuration changes
and enabling handset registration

NET CONNECTION PORT

for Ethernet cable

Gateway – frontview

NETWORK INDICATOR

Network indicator is flashing during boot. It indicates that the gateway has received an IP address

REGISTERED INDICATOR

indicates that the gateway is registered (at least one line)

CALL INDICATOR

is flashing during firmware update. Constant light indicates call in progress

POWER INDICATOR

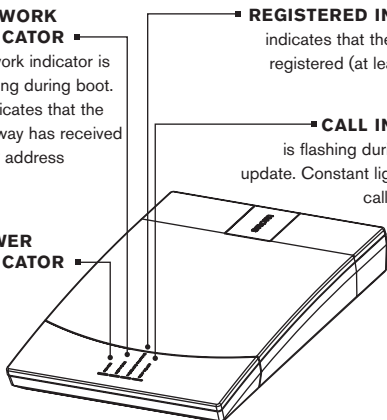

INSTALLING THE PHONE

This section guides you through the process of installing your **snom m3**.

Prerequisites

In order to take full advantage of the features of the **snom m3**, you need to have the following in place:

- Connection to a network
- SIP-User account information

Furthermore, before you start the installation process, make sure that you have the following close to the gateway:

- Wired Ethernet connection
- Power outlet for the gateway

NOTE: The gateway can either be placed on a tabletop or mounted on the wall. If longer cables are required, you can use ordinary cable extensions. The handset has an indoor signal range of up to 50 meters (150 feet) from the gateway, and you must place your handset charger within the signal range. Concrete and metal objects might affect the signal range.

Installing the gateway and registering the handset

HOW TO INSTALL THE GATEWAY

- 1) To prepare the gateway for SIP telephony, connect the Ethernet cable to the **NET** port on the gateway and then to a **LAN** port on your network.

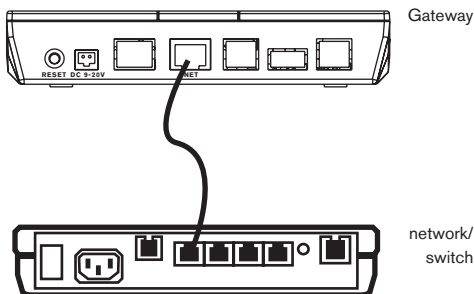

- 2) Connect the power adapter to the gateway and to an active power outlet (preferably a continuous power outlet without a switch to interrupt its power)

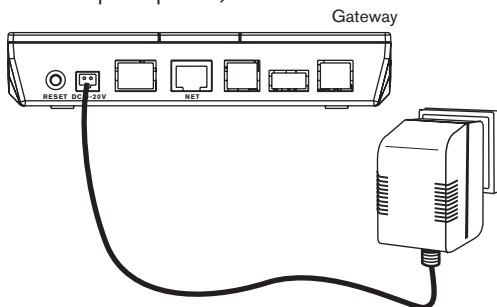

HOW TO INSTALL AND REGISTER THE HANDSET

- 1) Open the battery cover.

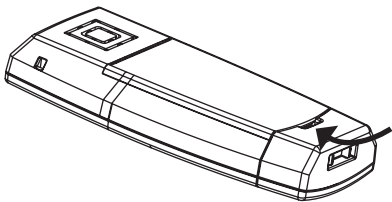

- 2) Insert the battery in the handset, making sure that contacts of battery are correct.

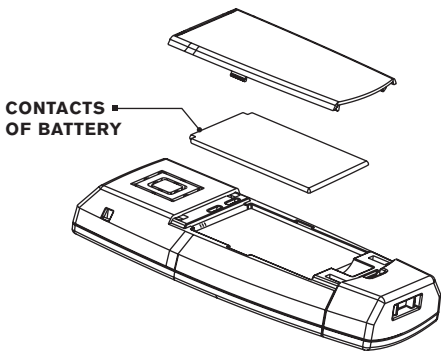

- 3) Connect the power adapter to the charger and the other end to an active power outlet (preferably a continuous outlet without a switch to interrupt its power).

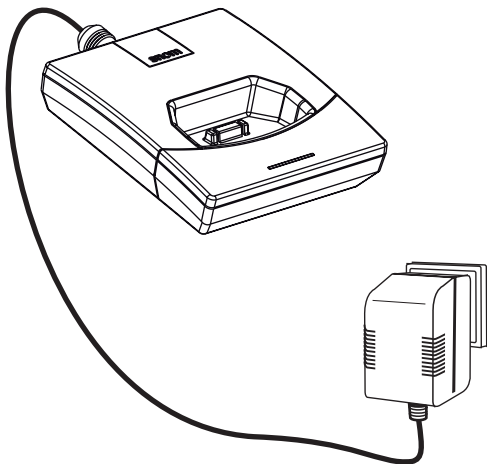

- 4) Place the handset in the charger, and charge the battery. We recommend that you charge the batteries fully before first use. This takes approximately 10 hours. When you place the handset in the charger, the handset automatically registers with the gateway.

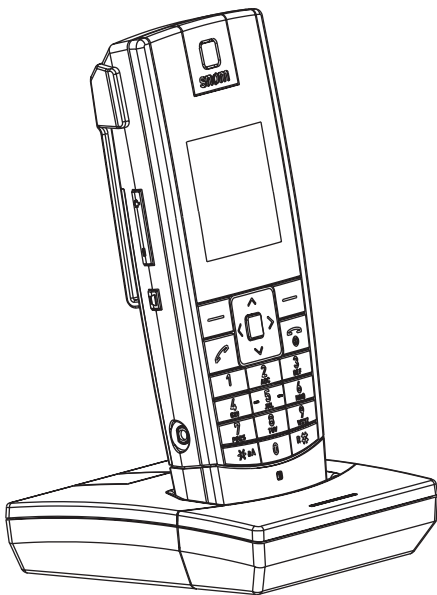

NOTE: After registration of the first handset, there is a 5-minute period during which you can register additional handsets. If you want to register additional handsets after the 5-minute period has expired, press the Reset button on the back of the gateway to start a new 5-minute registration period.

GETTING STARTED

Using the Menus and Typing Text and Numbers

The **snom m3** has 5 menus all of which you access from the Main menu.

HOW TO ENTER THE MAIN MENU

- 1) In Idle mode, press the **OK** key. The Main menu opens.

TYPING TEXT AND NUMBERS

When you are in a number editor or text editor use the Erase soft key to erase text that is already in the editor, or to erase text that you have just typed. The Options soft key in text mode only provides you with the following two options: Insert symbol and Input mode.

HOW TO INSERT A SYMBOL

- 1) In a text editor, press the Options soft key, choose Insert symbol, and then press the OK key.
- 2) Use the navigation keys to choose a symbol, and then press the OK key. The symbol is inserted in the text.

HOW TO CHANGE THE TEXT FORMAT

When you are in a text editor, the upper right corner of the display shows which text input mode is currently active. You can change the input mode of the text editor at any time during editing.

- 1) In a text editor, press the Options soft key, choose Input mode, and then press the OK key.
- 2) Choose the preferred input mode, and then press the OK key. The following options are available:

Option	What it does
ABC	Types upper case letters.
Abc	Types first letter in a sentence in upper case and remaining letters in lower case.
abc	Types lower case letters.
123	Types numbers only.

You can also change the case of letters on the fly or type a number in the middle of a text.

Press the **Star** key once to change the case, press the **Star** key twice to type numbers.

HOW TO LOCK AND UNLOCK THE KEYPAD

If you are carrying the handset around, you can lock the keypad so that you do not use it accidentally.

- 1) In **Idle** mode, press the **Star** key, and then press the **Lock** soft key.
- 2) To unlock, press the **Star** key, and then press the **Unlock** soft key.

NOTE: The keypad unlocks automatically when you answer an incoming call or when you make an emergency call.

Configuring the snom m3

The following sections describe how to configure and set up your **snom m3** for first use.

You have to configure your phone before it is ready for first use. You will need the account information that you received from your SIP Service Provider to complete the configuration of your **snom m3**.

HOW TO CONFIGURE USING A WEBBROWSER

- 1) Open a browser on your PC, go to the IP address of the gateway (Press the **volume up** key to get the IP address)
- 2) Log in to the menu. default settings:
username: admin
password: admin
- 3) In the menu, choose Identity 1 ... 8
- 4) Fill in the SIP user data:

- Server is local: Choose Yes or No
- Display name (optional): Caller ID that the called party sees
- Account: Usually the phone number you received from your service provider
- Password: the password you received from your SIP Provider
- Account name: Name of the account used in call groups
- Registrar: IP or DNS address of the SIP Server
- Outbound Proxy: IP or DNS address of the Outbound Proxy

Press the Save button. You will be redirected to the main page. Choose the Identity 1...8 again and press Reboot button to apply the settings. Please wait for the reboot of the Gateway.

After a few seconds, both status indicators in the upper left corner of the display will turn yellow, indicating that you have successfully configured your **snom m3**.

HOW TO CONFIGURE THE **snom m3** USING THE HANDSET

You can configure your **snom m3** using the handset.

- 1) In **Idle** mode, press the **OK** key, choose **Settings**, and then press the **OK** key.

- 2) Choose **VoIP settings**, and then press the **OK** key.
- 3) When prompted for a PIN code, type the default PIN code 0000, and then press the **OK** key.
- 3) Choose Accounts.

You then enter the data for the SIP account.

- 1) Choose the appropriate SIP account and fill in the user data.
- 2) If you have more than one SIP account, then you need to enter the account settings for each account.
- 3) Choose the listed parameters one by one, press the **OK** key.
 - Display name (optional) – Caller ID that the called party sees
 - User name – usually the phone number you received from your service provider
 - Authentication Name – usually the same as User name
 - Password – the password you received from your SIP provider
 - Account name – name of the account used in Call Groups
 - Registrar – IP or DNS address of the SIP server
 - Outbound Proxy – IP or DNS address of the Outbound Proxy
- 4) After each change, press the OK key and then the Yes soft key when prompted to save changes.

- 5) Press the Reset button on the rear of the gateway when you have completed all changes.

HOW TO CHANGE THE PIN CODE

Make sure to change the PIN code after first login to prevent unauthorized access to your VoIP settings.

- 1) In Idle mode, press the OK key, choose Settings, and then press the OK key.
- 2) Choose **VoIP settings**, and then press the OK key.
- 3) When prompted for a PIN code, enter the default PIN code 0000, and then press the OK key.
- 4) Choose **Change PIN code** and then press the **OK** key.
- 5) Enter a new PIN code, and then press the **OK** key.
- 6) Press the **Yes** soft key when prompted to save the PIN code.
- 7) For future reference, write down your new PIN code here:

--	--	--	--

NOTE: The handset PIN code and the online configuration password are independent of each other. Changing the handset PIN code will not affect the online configuration password.

HOW TO CHANGE ACCESS CODE

The access code is used for calculating encryption keys during the initial pairing of handsets to the gateway. To ensure privacy, the access code must be changed. Handset and gateway access codes must be the same.

When registering a new handset, ensure that its access code is modified to the same value as the access code of the gateway.

- 1) Enter Settings, System settings.
- 2) When prompted for a PIN code, type the PIN code (default: 0000), and then press the **OK**.
- 3) Choose **Access Code**.
- 4) Press **OK**.
- 5) Press **Gateway**.
- 6) Type in the new access code. Press **OK** and press **Yes** to save.

- 1) Enter Settings, System settings.
- 2) When prompted for a PIN code, type the PIN code (default: 0000), and then press the **OK**.
- 3) Choose **Access Code**.
- 4) Press **OK**.
- 5) Press **Handset**.
- 6) Type in the new access code. Press **OK** and press **Yes** to save.

Basic Settings

Before you start using your phone, we strongly recommend that you set handset language, country selection, time zone, and routing of emergency numbers to ensure that your **snom m3** functions properly.

HOW TO SET THE HANDSET LANGUAGE

The individual handset language setting determines in which language the text on the display is presented.

- 1) In the **Main** menu, choose **Settings**, and then press the OK key.
- 2) Choose **System settings**. When prompted for a PIN code, type the PIN code (default: 0000), and then press the **OK**, and then choose **Language**. Press the OK key.
- 3) Choose the preferred language, and then press the **OK** key.

HOW TO CHANGE THE TIME ZONE

Setting the time zone properly ensures that the time displayed in the Idle mode screen corresponds to the time zone you are in.

- 1) In the **Main** menu, choose **Settings**, and then press the OK key.
- 2) Choose **System settings**. When prompted

for a PIN code, type the PIN code (default: 0000). Choose **Time and date**. Press the OK key.

- 3) Choose **Time zone**, press the OK key, and then select the appropriate time zone. Press the OK key.

You should also verify that the time format and the daylight saving settings are correct. Date and time are automatically synchronized with a time server on the Internet to ensure that the time and date displayed on the **snom m3** is always correct.

HOW TO SET THE PRIMARY LINE FOR OUTGOING CALLS

You must set a primary line for each handset. This line is used for outgoing calls when you press the Green phone key. You can choose from eight SIP accounts.

- 1) In the **Main** menu, choose **Settings**, and then press the OK key.
- 2) Choose **Telephony settings**, press the OK key, and then choose **VoIP line**. Press the OK key.
- 3) When prompted for a PIN code, type the PIN code (default: 0000), and then press the OK.
- 4) Choose the account for the primary line, and then press the **OK** key.

HOW TO SET CALL GROUPS

If you have more than one handset, you must specify from which account or accounts you want each handset to receive calls. To do this you use Call Groups.

- 1) In the **Main** menu, choose **Settings**, and then press the OK key.
- 2) Choose **Telephony settings**, press the OK key, then choose **Call Groups** and then enter your PIN Code (the default PIN code is 0000). Press the OK key. All account names for the VoIP accounts you subscribe to are listed.

Clear any accounts for which you do not want the current handset to receive calls, and then press the OK key.

Updating the Firmware

To ensure that your **snom m3** has the latest features installed, we recommend that you update the firmware once you have configured and set up the phone.

HOW TO UPDATE THE FIRMWARE

When new software is available the display reads, **“New firmware available”**.

- 1) Press the OK key. The Firmware update menu appears.
- 2) To update to the latest version, choose the update listed on the **Simple** tab, press the OK key, and then press the Yes soft key when prompted whether you want to update the system. If you press the **View** soft key before you start the installation, you can find out about the software version number and the date and time it was released.
- 3) Select (if available) language and press **OK**.

The update time varies depending on the size of the update and the speed of your Internet connection. During the update process the following steps are listed in the display:

- Getting gateway
- Updating gateway
- Getting handset
- Updating handset



Once a step is complete, a green checkmark appears next to the step. When the entire update has been successfully completed, the display reads “**Upgraded to <version number>**”.

NOTE: While the update is in progress you cannot receive incoming calls or make calls, including emergency calls, on the **snom m3**. Also note that we recommend that you do not reset the gateway during the installation process.

MAKING AND ANSWERING CALLS

The following sections describe how to make calls with the **snom m3**.

When you make and receive Internet calls, the following icons are displayed:

- Calling 
- Ongoing call 

HOW TO MAKE A CALL

In **Idle** mode, type the number you want to dial and then press the **Green phone** key

HOW TO END A CALL

Press the **Red phone** key or place the handset in the charger.

HOW TO MAKE A CALL USING CONTACTS

- 1) In the **Main** menu, choose **Contacts**, and then press the **OK** key.

- 2) Choose the contact you want to call and then press the **Green phone** key. The default number is dialed.

If you want to call a contact and use another number than the default number, do the following:

- 1) In the **Main** menu, choose **Contacts** and then press the **OK** key.
 - 2) Choose the contact you want to call and then press the **OK** key.
 - 3) Choose a number from the list and then press the **Green phone** key.
- ### HOW TO MAKE A CALL USING THE CALL LOG

- 1) In **Idle** mode, press the **Call log** soft key or choose **Call log** from the **Main** menu and then press the **OK** key.
- 2) Choose the number you want to call and then press the **Green phone** key.

HOW TO MAKE A CALL USING REDIAL

- 1) Press the Options soft key, choose Redial and then press the OK key. The most recently dialed number is displayed.
- 2) Press the Green phone key to call the number.

HOW TO MAKE AN EMERGENCY CALL

Enter the emergency number and then press the **Green** phone key.

You cannot make emergency calls in the following situations:

- Firmware update is in progress
- Handset batteries are drained
- Power failure
- Handset is out of range of the gateway

HOW TO ANSWER A CALL

Pick up the handset and then press the **Green phone** key.

You can also set the **snom m3** to auto answer so that when you pick up the handset from the charger, you have automatically answered the call.

CALLWAITING – HOLD/UNHOLD

To switch between calls, you have to press the **hold** key. The call you had is put on hold.

To retrieve the call press the **Options** key, then select **Retrieve Call** and press the **OK** key or just press the **Red Phone** key.

MULTIPLE CALL HANDLING

To make another call you have to put the first party on hold, and then just dial the number of the second party as you would normally dial a number.

By pressing the **Options** key you then can

- Swap the calls,
- Initiate a 3-way conference,
- Or transfer the two active calls (join those two, see transferring calls for more details).

ATTENDED TRANSFER

If you receive a call, which you need to transfer to a third party, put the first caller on hold (see How to switch between two calls). Then dial the number of the party you want to connect the first caller. If the third party wants to talk to the first caller, press the **Options** key select **Transfer** and press **OK**.

The two parties get connected and the **snom m3** returns to idle mode.

UNATTENDED TRANSFER

When receiving a call and you want to transfer the call unattended to a third party press the **Hold** key then the **Options** key, then select **Transfer** and press the **OK** key. Enter the third party extension number and press the **OK** key. The call is transferred to the third party extension.

You will find the detailed User Guide on the Internet at www.snom.com.

WILLKOMMEN

Vielen Dank für den Erwerb des **snom m3**. Diese Bedienungsanleitung beschreibt die Installation, Konfiguration sowie die Benutzung des **snom m3**, um Gespräche über das SIP (Session Initiation Protocol) führen zu können.

Über diese Bedienungsanleitung

Diese Bedienungsanleitung besteht aus einer Reihe von Abschnitten, die Sie durch die Installation und Konfiguration führen bis zur ersten Inbetriebnahme. Es wird empfohlen vom Anfang bis zum Ende zu lesen. Weitere Abschnitte mit ausführlichen Beschreibungen der Eigenschaften finden Sie auf den Internetseiten der snom technology AG. In dieser Bedienungsanleitung werden die nachfolgenden Abkürzungen verwendet:

DHCP	– Dynamic Host Configuration Protocol
IP	– Internet Protocol
LAN	– Local-Area Network
NAT	– Network Address Translation
SIP	– Session Initiation Protocol
STUN	– Simple Traversal of UDP through NAT
URL	– Uniform Resource Locator
NET	– Network

Auf unserer Internetseite finden Sie weiterhin Hilfestellungen sowie häufig gestellte Fragen in der Wissensdatenbank.

www.snom.com

Bitte halten Sie die MAC-Adresse des Gerätes bereit, wenn Sie Ihren Support kontaktieren. Diese Nummer finden Sie auf der Unterseite der Basisstation (Gateway). Für Anfragen bezüglich Ihrer Netzwerkverbindung kontaktieren Sie bitte Ihren Netzwerkadministrator.

Für die EU: Die Konformität des Gerätes entspricht den EG-Richtlinien und wird durch das CE-Zeichen bestätigt. Hiermit wird bestätigt, dass snom m3 und/oder snom m3 Mobilteil konform mit den Anforderungen und Vorschriften der EG-Richtlinien 1999/5/EC sind.

Es wird empfohlen, ein Überspannungsschutzgerät zwischen Steckdose und diesem Gerät zu schalten, um Schäden, die durch Blitzschlag oder andere Arten von Überspannungen entstehen können, zu verhindern.

Installieren Sie das Mobilteil, die Ladeschale, das Netzteil, das Gateway, das Stromkabel und das Netzkabel nicht im Freien. NICHT FÜR DEN AUSSENBETRIEB GEEIGNET!

Sicherheitshinweise: Benutzen Sie nur die mitgelieferten Netzteile SALOM SSW-1444 für die Ladeschale und Sino American Modell A31230A/G/B oder SALOM SSW-1187US für die Basisstation.

Diese Produkt verwendet einen wiederaufladbaren Lithium-Ionen Akku 3,7V 650mAh. Es dürfen nur Akkus mit dem Firmenzeichen „snom“ und den P/N: 60020438 oder 60020438 verwendet werden, die dem Set beiliegen, sowie von der snom technology AG freigegebene Ersatztypen. Benutzen Sie keine anderen Akku-Typen, da dies zum Auslaufen, Feuer, Explosion oder zu anderen gefährlichen Situationen führen kann. Zum Ersetzen oder zum Entfernen des Akkus muss die Batterieabdeckung entfernt werden. Nehmen Sie den Akku niemals auseinander, nutzen Sie ihn nicht zweckentfremdet und verursachen keinen Kurzschluss. Platzieren Sie den Akku niemals in oder in der unmittelbaren Nähe von Feuer oder Hitze. Laden Sie den Akku nur im snom m3 Handgerät in Verbindung mit der snom m3 Ladeschale mit dem mitgelieferten Netzteil SALOM SSW-1444 auf.

Laden und Entladen von Akkus

Ihr Gerät wird von einem Akku versorgt. Ein neuer Akku erreicht seine volle Leistung erst, nachdem er zwei- oder dreimal vollständig ge- und entladen wurde. Der Akku kann mehrere hundert Mal ge- und entladen werden, nutzt sich aber im Laufe der Zeit ab. Verwenden Sie ausschließlich von der snom technology AG zugelassene Akkus.

Bei Nichtgebrauch entlädt sich ein voll aufgeladener Akku mit der Zeit. Ist der Akku vollständig entladen, dauert es möglicherweise einige Minuten, bis die Ladeanzeige im Handgerät (Display) eingeblendet wird oder Sie Anrufe tätigen können.

Benutzen Sie den Akku nur für den vorgesehenen Zweck. Benutzen Sie keine beschädigten Ladegeräte oder Akkus. Schließen Sie den Akku nicht kurz. Durch Kurzschließen der Pole können der Akku oder der verbindende Gegenstand beschädigt werden.

Die Kapazität und Lebensdauer des Akkus wird verkürzt, wenn er an kalten oder warmen Orten liegen gelassen wird. Laden Sie die Akkus nur in einer Umgebungstemperatur von 0° C bis 40° C. Ein Gerät mit einem kalten oder warmen Akku funktioniert unter Umständen vorübergehend nicht, selbst wenn der Akku vollständig geladen ist. Einfaches und vor allem mehrfaches Überladen des Akkus führt zu einer übermäßigen Alterung. Laden Sie niemals den Akku mit verkehrter Polarität, da dies zu Gasbildungen im Inneren des Akkus führen kann, welche wiederum Leckagen herbeiführen können. Für kurzfristige Lagerungen ist ein Ort mit niedriger Luftfeuchtigkeit und ohne korrosive Gase bei einer Temperatur von -20° C bis 45° C zu wählen. Für langfristige Lagerungen sind Temperaturen zwischen 10° C und 30° C einzuhalten.

Informationen zur Batterieentsorgung

Werfen Sie Akkus nicht ins Feuer, da sonst Explosionsgefahr besteht! Akkus können ebenfalls explodieren, wenn sie beschädigt sind. Akkus müssen ordnungsgemäß entsorgt werden. Führen Sie diese der Wiederverwertung zu, soweit dies möglich ist. Defekte oder verbrauchte Akkus sind nicht über den Hausmüll zu entsorgen.

Verbrennen Sie niemals Akkus.

Zusätzliche Sicherheitshinweise

Kleinkinder:

Das Gerät und sein Zubehör können Kleinteile enthalten. Halten Sie diese außerhalb der Reichweite von kleinen Kindern.

Betriebsumgebung:

Vergessen Sie nicht, die in bestimmten Bereichen gültigen besonderen Vorschriften zu beachten und immer dann das Gerät auszuschalten, wenn sein Einsatz verboten ist oder wenn es durch das Gerät zu Störungen kommen oder Gefahr entstehen kann. Halten Sie das Gerät stets in seiner vorgesehenen Bedienungsposition. Bringen Sie keine Kreditkarten oder andere magnetische Datenträger in die Nähe des Geräts, da auf diesen enthaltene Daten hierdurch gelöscht werden können.

Medizinische Geräte:

Der Betrieb von Funkgeräten kann unter Umständen die Funktionalität von nicht ausreichend abgeschirmten medizinischen Geräten stören. Wenden Sie sich an einen Arzt oder den Hersteller des medizinischen Geräts, um festzustellen, ob diese ausreichend gegen externe Hochfrequenzemissionen abgeschirmt sind oder wenn Sie Fragen zu anderen Themen haben.

Schalten Sie Ihr Gerät in Gesundheitseinrichtungen aus, wenn Sie durch in diesen Bereichen aufgestellte Vorschriften dazu aufgefordert werden. Krankenhäuser oder Gesundheitseinrichtungen können unter Umständen Geräte verwenden, die auf externe Hochfrequenzemissionen sensibel reagieren können.

Implantierte medizinische Geräte:

Hersteller medizinischer Geräte empfehlen einen Mindestabstand von 15,3 Zentimeter zwischen Funkgeräten und implantierten medizinischen Geräten wie z. B. Herzschrittmachern oder implantierten Cardioverttern/Defibrillatoren, um eine mögliche Störung des medizinischen Geräts zu vermeiden.

Personen, die Geräte dieser Art verwenden,

- müssen immer einen Abstand von 15,3 Zentimetern zwischen medizinischem Gerät und Funkgerät einhalten, wenn das Funkgerät eingeschaltet ist,
- dürfen das Funkgerät nicht in der Brusttasche aufbewahren,
- müssen das Gerät an das dem medizinischen Gerät entferntere Ohr halten, um die Gefahr möglicher Störungen zu verringern,
- müssen ihr Funkgerät umgehend ausschalten, wenn sie Grund zu der Vermutung haben, dass es zu einer Störung gekommen ist,
- müssen die Anweisungen des medizinischen Geräteherstellers lesen und befolgen.

Wenn Sie Fragen hinsichtlich der Verwendung des Funkgeräts zusammen mit einem implantierten medizinischen Gerät haben, wenden Sie sich an Ihren Arzt.

Explosionsgefährdete Orte

Schalten Sie Ihr Gerät an Orten mit einer explosionsgefährdeten Atmosphäre aus und handeln Sie entsprechend den Schildern und Anweisungen. An solchen Orten kann ein Funke eine Explosion auslösen oder einen Brand mit körperlichen Schäden oder Todesfolge auslösen. Schalten Sie das Gerät an Tankstellen und in der Nähe von Benzinpumpen aus. Beachten Sie die Einschränkungen in Bezug auf den Einsatz von Funkgeräten in Kraftstoffdepots, -lagern und in Verkaufsbereichen, chemischen Anlagen oder Sprenggebieten. Orte, an denen Explosionsgefahr besteht, sind zwar häufig, aber nicht immer deutlich gekennzeichnet. Hierzu gehören beispielsweise das Unterdeck auf Schiffen, Umgebungen von Leitungen und Tanks, in denen sich Chemikalien befinden, Fahrzeuge, die mit Flüssiggas betrieben werden, sowie Orte, an denen sich Chemikalien oder Partikel wie Getreidestaub, Staub oder Metallpulver in der Luft befinden.

Die snom technology AG behält sich jederzeit das Recht auf Überarbeitung und Änderung dieses Dokumentes vor, ohne dabei verpflichtet zu sein, die vorgenommenen Änderungen anzukündigen oder zu melden.

AUF EINEM BLICK

Mobilteil – Vorderansicht

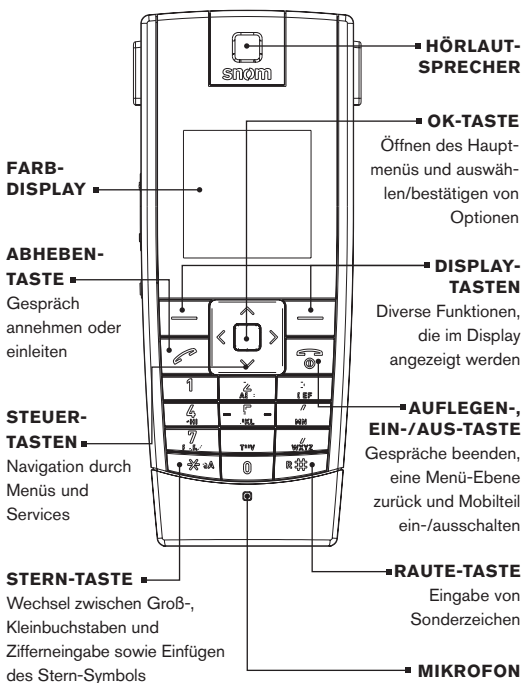

Mobilteil – Seitenansicht

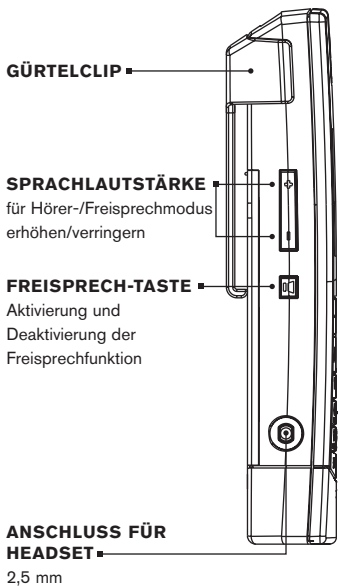

Mobilteil-Ladeschale – Vorderansicht

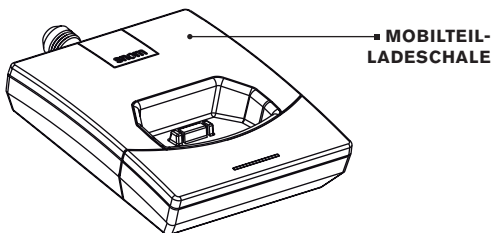

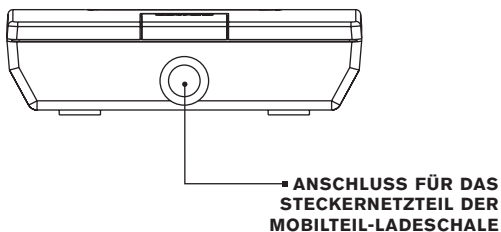

Mobilteil-Ladeschale – Rückansicht

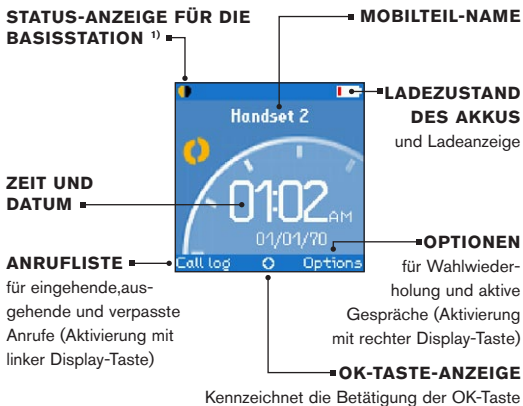

Display – Ruhezustand



1)

-  Schwarz / schwarz – Das Mobilteil befindet sich außerhalb der Reichweite der Basisstation
-  Gelb / schwarz – Das Mobilteil befindet sich in Reichweite der Basisstation, ist aber nicht bereit für SIP-Anrufe
-  Gelb / gelb – Das Mobilteil befindet sich in Reichweite der Basisstation und ist bereit für SIP-Anrufe

Display – Hauptmenü

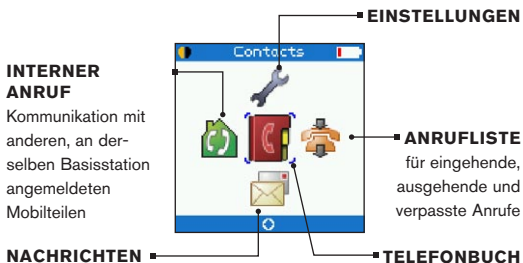

Basisstation – Rückansicht

ANSCHLUSS FÜR DAS STECKERNETZTEIL DER BASISSTATION

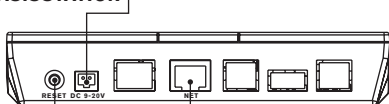

RESEY-TASTE

Aktivierung von Konfigurationsänderungen und Anmeldung von Mobilteilen

NETZWERK-ANSCHLUSS (LAN)

für Netzwerkkabel

Basisstation – Vorderansicht

NETWORK-ANZEIGE

blinkt während des Startvorgangs und leuchtet bei Empfang einer IP-Adresse

POWER-ANZEIGE

der eingeschalteten Energieversorgung

REGISTERED-ANZEIGE

signalisiert die erfolgreiche Anmeldung von mindestens einem SIP-Konto

CALL-ANZEIGE

blinkt während der Aktualisierung der Firmware und leuchtet bei Telefonaten

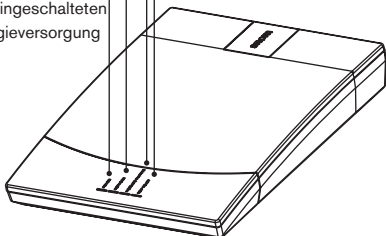

INSTALLATION

Voraussetzungen

Folgende Umgebung ist für den Betrieb des **snom m3** notwendig:

- Zugang zu einem geeigneten Netzwerk (LAN), kabelgebunden
- Steckdosen zur Versorgung mit elektrischer Energie (Basisstation und Mobilteil-Ladeschale)
- SIP-Konto Daten

HINWEIS: Die Basisstation kann sowohl auf den Tisch gestellt als auch an die Wand montiert werden. Falls längere Kabel benötigt werden, können gebräuchliche Verlängerungen eingesetzt werden. Das Mobilteil hat in Gebäuden eine Reichweite von ungefähr 50 Metern (150 feet) zur Basisstation. Die Mobilteil-Ladeschale muss sich in diesem Bereich befinden. Beton- und Metallobjekte beeinflussen die Reichweite.

Installation der Basisstation und Registrierung des Mobilteils

INSTALLATION DER BASISSTATION

- 1) Zur Vorbereitung von Telefonaten via SIP verbinden Sie mittels eines geeigneten Kabel den mit **NET** gekennzeichneten Anschluss mit einem **LAN** Anschluss Ihres Netzwerkes.

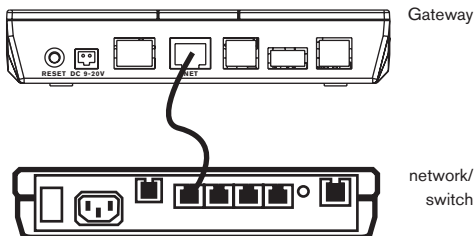

- 2) Verbinden Sie das Steckernetzgerät sowohl mit der Basisstation als auch mit der Steckdose (bevorzugt mit Überspannungsschutz)

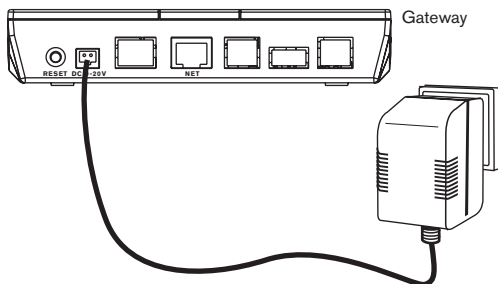

MOBILTEIL INSTALLIEREN UND REGISTRIEREN

- 1) Falls montiert, den Gürtelclip abnehmen und den Deckel des Akkufachs gemäß Zeichnung nach oben ziehen.

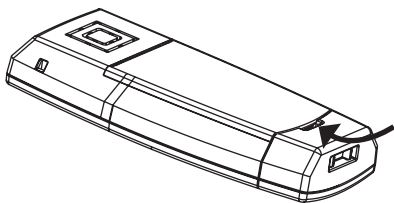

- 2) Den Akku in das Fach einsetzen und dabei auf die richtige Polarität achten. Anschließend den Deckel schließen.

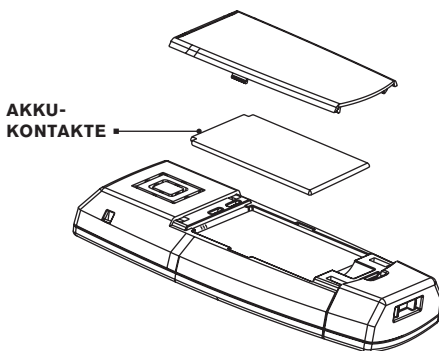

- 3) Verbinden Sie das Steckernetzteil sowohl mit der Mobilteil-Ladeschale als auch mit der Steckdose (bevorzugt mit Überspannungsschutz.)

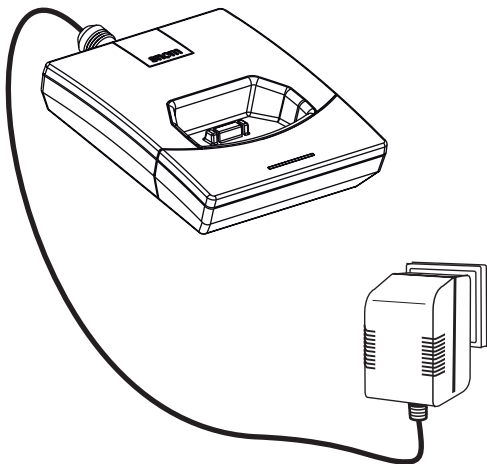

- 4) Stellen Sie das Mobilteil in die Ladeschale und laden Sie den Akku. Wir empfehlen den Akku, vor dem ersten Gebrauch vollständig aufzuladen. Dies dauert ungefähr 10 Stunden. Wenn Sie das Mobilteil in die Ladeschale stellen, registriert sich das Mobilteil automatisch bei der Basisstation.

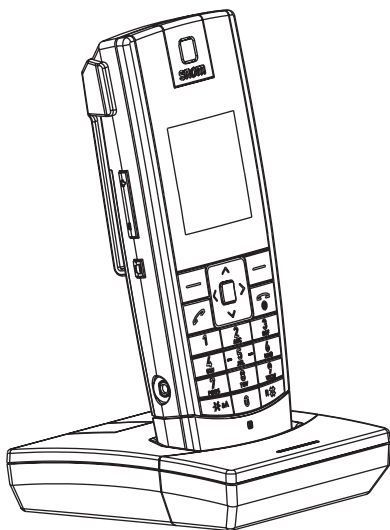

HINWEIS: Nach der Anmeldung des ersten Mobilteils gibt es einen 5-minütigen Zeitraum, um weitere Geräte zu registrieren. Wenn Sie weitere Mobilteile nach diesen 5 Minuten an der Basisstation anmelden möchten, drücken Sie bitte die Reset-Taste auf der Rückseite der Basisstation, um einen neuen 5-minütigen Zeitraum für die Registrierung zu starten.

ERSTE SCHRITTE

Benutzen des Menüs und Eingabe von Zahlen und Buchstaben

Eingeschaltet wird das Mobilteil durch längeres Drücken der Auflage-Taste. Im Auslieferungszustand ist die Menüsprache Englisch. Mit den nachfolgenden Schritten können Sie die Sprache auf Deutsch umstellen.

- 1) Drücken Sie die OK-Taste, wählen Sie **Settings** und drücken Sie anschließend erneut die OK-Taste.
- 2) Wählen Sie nun **System settings** aus und drücken Sie wieder die OK-Taste.
- 3) Sie werden aufgefordert, den PIN-Code einzugeben. Die Werkseinstellung ist 0000. Drücken Sie die OK-Taste.
- 4) Nun gehen Sie zum Menüpunkt **Language** und drücken Sie die OK-Taste.
- 5) Wählen Sie nun **Deutsch** aus und drücken Sie wieder die OK-Taste.
- 6) Durch mehrmaliges Drücken der **Auflage**-Taste verlassen Sie das Menü.

Das Mobilteil ist nun auf die deutsche Sprache umgestellt. Alle folgenden Kapitel nutzen die deutsche Menüsprache.

Das **snom m3** hat fünf Menüpunkte, die Sie vom Hauptmenü aus erreichen können.

HAUPTMENÜ

Drücken Sie im Ruhezustand die **OK**-Taste, um in das Hauptmenü zu gelangen.

EINGABE VON ZAHLEN UND BUCHSTABEN

Wenn Sie sich im Eingabemodus für Zahlen oder Buchstaben befinden, können Sie mit der linken Display-Taste (**Löschen**) die Eingabe löschen. Mit der rechten Display-Taste (**Optionen**) können Sie im Textmodus den **Eingabemodus** ändern oder ein **Symbol einfügen**.

EINGABE VON SYMBOLEN

Wenn Sie sich im Eingabemodus befinden, drücken Sie die rechte Display-Taste (**Optionen**) und wählen dann **Symbol einfügen**, in dem Sie die **OK**-Taste betätigen. Benutzen Sie bitte die Steuer-Tasten, um das gewünschte Symbol auszuwählen. Mit der **OK**-Taste übernehmen Sie das Symbol für Ihren Text.

EINGABEMODUS ÄNDERN

Wenn Sie sich im Eingabemodus befinden, sehen Sie in der oberen rechten Ecke des Eingabefensters die derzeit ausgewählte Option. Der Eingabemodus kann wie nachfolgend beschrieben geändert werden.

- 1) Drücken Sie die rechte Display-Taste (**Optionen**), wählen Sie Eingabemodus und drücken Sie dann die **OK**-Taste.
- 2) Wählen Sie den gewünschten Eingabemodus aus und drücken Sie anschließend die **OK**-Taste. Sie können unter den nachfolgend beschriebenen Optionen auswählen:

Option	Funktion
ABC	Alle Buchstaben werden großgeschrieben.
Abc	Erster Buchstabe eines Wortes großgeschrieben, alle weiteren klein.
abc	Alle Buchstaben werden kleingeschrieben.
123	Eingabe von Ziffern.

Alternativ können Sie auch durch Drücken der **Stern**-Taste den Eingabemodus ändern.

TASTATURSPERRE EIN-/AUSSCHALTEN

Um eine versehentliche Benutzung zu vermeiden, können Sie die Tastatur des Mobilteils sperren.

- 1) Drücken Sie im Ruhezustand die Stern-Taste und anschließend die rechte Display-Taste zum Sperren.
- 2) Zum Ausschalten der Tastensperre drücken Sie ebenfalls die Stern-Taste und danach die rechte Display-Taste zum Freigeben.

HINWEIS: Die Tastatursperre schaltet sich bei einem ankommenden Anruf oder bei Betätigung eines Notrufs automatisch aus und anschließend wieder ein.

Konfigurieren

Der nachfolgende Abschnitt beschreibt die Konfiguration und die Einrichtung des **snom m3** für den ersten Gebrauch.

Das Gerät muss unbedingt konfiguriert werden, damit es betriebsbereit ist. Sie benötigen die SIP-Kontoeinstellungen Ihres Anbieters, um die Einrichtung des **snom m3** abzuschließen.

KONFIGURATION ÜBER DEN WEBBROWSER

1. Öffnen Sie einen Webbrowser auf Ihrem PC und geben Sie die IP-Adresse der Basisstation ein. Drücken Sie die seitliche Lautstärketaste zur Erhöhung der Lautstärke, um die IP-Adresse des Gerätes angezeigt zu bekommen. Beispiel: <http://192.168.1.238/>
2. Anmelden mit
username: admin
password: admin
3. Wählen Sie im Menü die Identität (**Identity**) aus, die Sie konfigurieren möchten. Es können gleichzeitig bis zu 8 verschiedene SIP-Konten angemeldet sein.

4. Füllen Sie die Eingabefelder aus:
- Server is local: Wählen Sie Yes oder No
 - Display Name (optional): Anruferkennung, wie sie vom Angerufenen gesehen wird
 - Account: SIP-Anmeldename (üblicherweise die Rufnummer vom Anbieter)
 - Password: Passwort zum zugehörigen SIP-Anmeldename
 - Account Name (optional): Name, wie er in Anrufgruppen verwendet wird
 - Registrar: IP oder DNS Adresse vom SIP-Server
 - Outbound Proxy (optional): IP oder DNS Adresse des Proxy, über den die Daten geschickt werden

Klicken Sie auf die Taste **Save**. Anschließend werden Sie auf die Hauptseite zurückgeleitet. Wählen Sie nun wieder die Identität (Identity) aus und klicken Sie auf **Reboot**, um die Änderungen zu übernehmen. Bitte warten Sie den Neustart der Basisstation ab.

Nach wenigen Sekunden sollten beide Status-Anzeigen in der oberen linken Ecke des Displays in gelb erscheinen. Dies signalisiert die erfolgreiche Registrierung des **snom m3**.

KONFIGURATION ÜBER DAS MOBILTEIL

Das **snom m3** kann ebenfalls über das Menü des Mobilteils konfiguriert werden.

- 1) Drücken Sie im Ruhezustand die OK-Taste, wählen Sie **Einstellungen** und drücken Sie anschließend die OK-Taste.
- 2) Wählen Sie nun **VoIP-Einstellungen** aus und drücken Sie wieder die OK-Taste.
- 3) Sie werden aufgefordert, den PIN-Code einzugeben. Die Werkseinstellung ist 0000. Drücken Sie die OK-Taste.
- 4) Wählen Sie die Konten aus.

Jetzt können die Eingaben für die SIP-Konten vorgenommen werden.

- 1) Wählen Sie das zu konfigurierende **Konto** aus und tragen Sie Ihre SIP-Anmeldedaten in die entsprechenden Felder ein.
- 2) Wenn Sie weitere Konten registrieren möchten, müssen Sie die Daten für jedes Konto einzeln eingeben.
- 3) Wählen Sie die nachfolgenden Parameter aus und drücken Sie jeweils die OK-Taste
 - Anzeigename: Anruferkennung, wie sie vom Angerufenen gesehen wird
 - Benutzername: SIP-Anmeldename (üblicherweise die Rufnummer vom Anbieter)
 - Authentif.-Name: gewöhnlich wie Benutzername
 - Passwort: Passwort zum zugehörigen SIP-Anmeldenamen
 - Account name (optional): Name, wie er in Anrufgruppen verwendet wird

- Registrar: IP oder DNS-Adresse des SIP-Server
 - Outbound Proxy: (optional): IP oder DNS-Adresse des Proxy, über den die Daten geschickt werden
- 4) Jede Eingabe wird mit der OK-Taste beendet. Sie werden anschließend gefragt, ob Sie die Änderung **Speichern** möchten. Zur Übernahme der Änderung drücken Sie die linke Display-Taste für **Ja**.
 - 5) Drücken Sie die **Reset**-Taste auf der Rückseite der Basisstation, wenn Sie alle Änderungen vorgenommen haben.

PIN CODE ÄNDERN

Um nicht autorisierten Zugang bei den VoIP-Einstellungen zu verhindern, kann der PIN-Code geändert werden.

- 1) Drücken Sie im Ruhezustand die OK-Taste, wählen Sie Einstellungen und drücken Sie anschließend die OK-Taste.
- 2) Wählen Sie nun VoIP-Einstellungen aus und drücken Sie wieder die OK-Taste.
- 3) Sie werden aufgefordert den (alten) PIN-Code einzugeben. Die Werkseinstellung ist 0000. Drücken Sie die OK-Taste.
- 4) Wählen Sie nun „PIN ändern“ aus und drücken Sie wieder die OK-Taste.
- 5) Geben Sie den neuen PIN ein und bestätigen Sie mit der OK-Taste.

- 6) Drücken Sie die linke Display-Taste für Ja, um die Änderung zu übernehmen.
- 7) Zum späteren Nachschlagen können Sie den neuen PIN-Code hier notieren:

--	--	--	--

HINWEIS: Der PIN-Code des Mobilteils und der Zugang für die Webbrowser Einstellungen sind unabhängig voneinander. Die Änderung der Mobilteil-PIN hat keinen Einfluss auf das Passwort für den Webbrowser-Zugriff.

ZUGANGSCODE ÄNDERN

Der Zugangscodewird für die Berechnung der Codierungsschlüssel zwischen Basisstation und Mobilteil verwendet. Um die Übertragungsdaten zu schützen, muss der Zugangscodew geändert werden, wobei sowohl Mobilteil als auch Basisstation den gleichen Zugangscodew haben müssen. Wenn Sie weitere Mobilteile hinzufügen, müssen Sie ebenfalls den Zugangscodew der Basisstation erhalten.

- 1) Drücken Sie im Ruhezustand die OK-Taste, wählen Sie **Einstellungen** und drücken Sie anschließend die OK-Taste.
- 2) Wählen Sie nun **Systemeinstellungen** aus und drücken Sie wieder die OK-Taste.
- 3) Sie werden aufgefordert, den PIN-Code einzugeben. Die Werkseinstellung ist 0000. Drücken Sie die OK-Taste.
- 4) Wählen Sie nun **Zugangscodew** aus und drücken Sie wieder die OK-Taste.

- 5) Drücken Sie nochmals die OK-Taste, um die **Basisstation** auszuwählen.
- 6) Geben Sie den neuen **Zugangscode** ein und bestätigen Sie mit der OK-Taste.
- 7) Drücken Sie die linke Display-Taste für **Ja**, um die Änderung zu übernehmen.
- 8) Anschließend wählen Sie **Mobilteil** aus und drücken wieder die OK-Taste.
- 9) Es folgt der Hinweis im Display: „Bitte auch PIN der Basis einstellen“. Drücken Sie erneut die OK-Taste, um nun den Zugangscode für das Mobilteil einzugeben. Dieser muss mit dem Zugangscode der Basisstation übereinstimmen. Bestätigen Sie die Eingabe mit der OK-Taste.
- 10) Drücken Sie die linke Display-Taste für **Ja**, um die Änderung zu übernehmen.
- 11) Durch mehrmaliges Drücken der **Auflege-**Taste verlassen Sie die Menüs bis zum Ruhezustand.

Grundeinstellungen

Wir empfehlen, für das Mobilteil, die Einstellungen für Sprache, Länderauswahl, Zeitzone und Notrufnummern vorzunehmen, um den ordentlichen Betrieb des Gerätes zu gewährleisten.

EINSTELLUNG DER MOBILTEILSPRACHE

Die Änderung der Mobilteil-Sprache ist bereits am Anfang des Kapitels ERSTE SCHRITTE beschrieben worden.

ÄNDERUNG DER ZEITZONE

Damit Uhrzeit und Datum auf dem Ruhebildschirm des Mobilteils richtig angezeigt werden, ist die Einstellung der entsprechenden Zeitzone notwendig.

- 1) Drücken Sie im Ruhezustand die OK-Taste, wählen Sie **Einstellungen** und drücken Sie anschließend die OK-Taste.
- 2) Wählen Sie nun **Systemeinstellungen** aus und drücken Sie wieder die OK-Taste.
- 3) Sie werden aufgefordert, den PIN-Code einzugeben. Die Werkseinstellung ist 0000. Drücken Sie die OK-Taste.
- 4) Wählen Sie nun **Uhrzeit und Datum** aus und drücken Sie wieder die OK-Taste.
- 5) Gehen Sie mit den Steuer-Tasten zu dem Menüpunkt **Zeitzone** und drücken Sie erneut die OK-Taste.
- 6) Wählen Sie die gewünschte **Zeitzone** aus und bestätigen Sie die Eingabe durch Drücken der OK-Taste.
- 7) Durch mehrmaliges Drücken der **Auflege**-Taste verlassen Sie die Menüs bis zum Ruhezustand.

Falls gewünscht/erforderlich, nehmen Sie jetzt die Einstellungen für **Uhrzeitformat**, **Datumsformat** und **Sommerzeit** vor. Diese Einstellungen befinden sich ebenfalls im Untermenü **Uhrzeit und Datum**. Datum und Uhrzeit sind werksseitig mit einem Zeitserver im Internet synchronisiert. Dies stellt sicher, dass beides korrekt angezeigt wird.

AUSWAHL DES SIP-KONTOS FÜR ABGEHENDE GESPRÄCHE

Sie müssen das SIP-Konto auswählen, welches Sie für abgehende Gespräche verwenden möchten. Sie können aus bis zu 8 SIP-Konten auswählen.

- 1) Drücken Sie im Ruhezustand die OK-Taste, wählen Sie **Einstellungen** und drücken anschließend die OK-Taste.
- 2) Wählen Sie nun **Telefonieeinstell.** aus und drücken wieder die OK-Taste.
- 3) Wählen Sie nun **VoIP-Verbindungen** aus und drücken Sie wieder die OK-Taste.
- 4) Sie werden aufgefordert, den PIN-Code einzugeben. Die Werkseinstellung ist 0000. Drücken Sie die OK-Taste.
- 5) Gehen Sie zum gewünschten SIP-Konto und bestätigen Sie die Eingabe mit der OK-Taste.

KONFIGURIEREN VON ANRUFGRUPPEN

Wenn Sie mehr als ein Mobilteil haben, müssen Sie einstellen, welches Mobilteil von welchem SIP-Konto aus erreicht werden soll. Um dies zu ermöglichen, müssen Sie mit Anrufgruppen arbeiten.

- 1) Drücken Sie im Ruhezustand die OK-Taste, wählen Sie **Einstellungen** und drücken Sie anschließend die OK-Taste.

- 2) Wählen Sie nun **Telefonieinstall.** aus und drücken Sie wieder die OK-Taste.
- 3) Wählen Sie jetzt Anrufgruppen aus und bestätigen Sie mit der OK-Taste.
- 4) Sie werden aufgefordert den PIN-Code einzugeben. Die Werkseinstellung ist 0000. Drücken Sie die OK-Taste.
- 5) Alle verfügbaren SIP-Konten werden angezeigt

Sie können für das betroffene Mobilteil die jeweiligen Konten aktivieren bzw. deaktivieren. Der jeweilige Status wird durch eine grüne Kontrollmarkierung im Display angezeigt.

Aktualisierung der Firmware

Um sicherzustellen, dass die Firmware Ihres Gerätes auf dem neuesten Stand ist, wird die Durchführung einer Aktualisierung empfohlen.

WIE WIRD DIE FIRMWARE AKTUALISIERT

Wenn ein Update erhältlich ist, erscheint im Display eine entsprechende Nachricht.

- 1) Drücken Sie die OK-Taste, um die Aktualisierung durchzuführen.
- 2) Bestätigen Sie die Auswahl der Version und

drücken Sie erneut die OK-Taste. Alternativ können Sie mit der rechten Display-Taste für **Ansicht** weitere Informationen abrufen.

- 3) Wählen Sie – falls vorhanden – die Sprache aus.
- 4) Anschließend müssen Sie den Vorgang nochmals bestätigen, indem Sie die linke Display-Taste für **Ja** betätigen.

Die benötigte Zeit für die Aktualisierung der Firmware ist abhängig von der Größe der Aktualisierungsdatei und der Internet-Geschwindigkeit. Während des Vorgangs werden folgende Einzelschritte angezeigt:

- Basisstation synch
- Basisst. wird akt.
- Mobilteil synchr.
- Mobilteil wird akt.

Die Beendigung eines Schrittes wird durch die Anzeige einer grünen Kontrollmarkierung dargestellt. Am Ende der Aktualisierung erscheint im Display eine Nachricht: „Aktualis. auf: v....“. Drücken Sie zum Abschluss die OK-Taste, um in den Ruhebildschirm zu gelangen.

HINWEIS: Während der Aktualisierung der Firmware können Sie keine Gespräche führen (einschließlich Notrufe). Drücken Sie während der Aktualisierung nicht die Reset-Taste auf der Rückseite der Basisstation.

TELEFONIEREN

In diesem Abschnitt finden Sie die Beschreibung zur Durchführung von Telefongesprächen.

Bei ein-/ ausgehenden Anrufen bzw. wenn das Gerät verbunden ist, sehen Sie die folgenden Symbole im Display:

- Anruf 
- Verbundenes Gerät 

EIN GESPRÄCH EINLEITEN

Um einen Anruf zu tätigen, führen Sie die nachfolgenden Schritte durch.

- Geben Sie im Ruhezustand des Mobilteils die gewünschte Rufnummer ein und drücken anschließend die grüne Abheben-Taste.

EIN GESPRÄCH BEENDEN

- Drücken Sie die rote Auflegen-Taste oder stellen Sie das Mobilteil in die zugehörige Ladeschale.

ANRUFÜBER DAS TELEFONBUCH

- 1) Drücken Sie im Ruhezustand die OK-Taste, wählen Sie **Telefonbuch** und drücken Sie anschließend erneut die OK-Taste.
- 2) Wählen Sie mit den Steuertasten den gewünschten Kontakt aus
- 3) Drücken Sie nun die grüne Abheben-Taste, um mit der Standard-Rufnummer des Kontaktes verbunden zu werden.

Wenn Sie eine andere Nummer als die Standard-Rufnummer des Kontaktes wählen möchten, müssen Sie wie folgt verfahren:

- 1) Drücken Sie im Ruhezustand die OK-Taste, wählen Sie **Telefonbuch** und drücken Sie anschließend erneut die OK-Taste.
- 2) Wählen Sie mit den Steuertasten den gewünschten Kontakt aus
- 3) Betätigen Sie nun die OK-Taste und wählen Sie mit den Steuertasten die gewünschte Rufnummer des Kontaktes aus.
- 4) Drücken Sie nun die grüne Abheben-Taste, um mit dieser Rufnummer verbunden zu werden.

ANRUFÜBER ANRUFLISTE

- 1) Drücken Sie im Ruhezustand die linke Display-Taste für **Anrufliste**.
- 2) Wählen Sie mit den Steuertasten die gewünschte Rufnummer aus und drücken Sie anschließend die grüne Abheben-Taste.

WAHLWIEDERHOLUNG

- 1) Drücken Sie im Ruhezustand die rechte Display-Taste für **Optionen**.
- 2) Wählen Sie nun **Wahlwiederholung** aus, indem Sie die OK-Taste drücken.
- 3) Nun wird die zuletzt gewählte Rufnummer angezeigt.
- 4) Drücken Sie nun die grüne Abheben-Taste, um den Anruf zu starten.

NOTRUF

Geben Sie die lokale Notrufnummer ein und drücken Sie anschließend die grüne Abheben-Taste.

In den nachfolgenden Situationen kann kein Notruf durchgeführt werden:

- Während der Aktualisierung der Firmware.
- Wenn der Akku des Mobilteils entladen ist.
- Ausfall oder Fehler in der Energieversorgung.
- Das Mobilteil befindet sich außerhalb der Reichweite der Basisstation

ANRUF ENTGEGENNEHMEN

- Nehmen Sie das Mobilteil und drücken Sie die grüne Abheben-Taste.

Sie können im Menü einstellen, dass das **snom m3** den Anruf automatisch entgegennimmt, wenn das Mobilteil aus der Mobilteil-Ladeschale entnommen wird.

MAKELN (HALTEN/WIEDERAUFNAHME)

Um zwischen zwei Gesprächen zu makeln müssen Sie den ersten Anruf halten. Drücken Sie dazu die **Halten** Taste.

Um den Anruf zurückzuholen drücken Sie **Optionen** Taste, wählen Sie **Ruf wiederaufnehmen**, drücken Sie die **OK** Taste, alternativ können Sie auch die **Rote Telefontaste** drücken.

MEHRERE PARALLELE ANRUF

Während Sie einen Anruf halten können Sie eine Rückfrage initiieren, indem Sie einfach wie gewohnt wählen.

Durch drücken der **Optionen** Taste, stehen ihnen folgende Funktionen zur Verfügung:

- Anrufe tauschen
- Konferenz (lokale 3er Konferenz im **snom m3**)
- Weiterleiten (Transfer/Verbinden der beiden aktiven Anrufe)

ANRUFWEITERLEITUNG MIT VORHERIGER ANKÜNDIGUNG

Wenn Sie einen Anruf für jemand dritten Empfangen, und vor dem Weiterleiten Rückfragen wollen. Legen die den Anrufer auf Halten (siehe Makeln), wählen sie die Rufnummer des dritten den der Anrufer sprechen möchte. Falls dieser den Anruf entgegennehmen möchte drücken Sie die **Optionen** Taste, wählen Sie **Weiterleiten** aus und drücken Sie **OK**.

Die zwei aktiven Gespräche werden miteinander verbunden und das **snom m3** kehrt in den Ruhezustand zurück.

Weitere Information finden Sie in der ausführlichen Bedienungsanleitung im Internet unter:

www.snom.com

SAFETY INFORMATION & WARRANTY

USA

Intended Use

This telephone is designed for telephoning within the Internet. Any other use is considered unintended use. Any modification or reconstruction not described in the user manual is considered unintended use.

IMPORTANT SAFETY INFORMATION

Follow all instructions and warnings in the user manual, and on the equipment to prevent accidents.

WARNING

Fire, electric shock, or other injury may result if you do not observe the following safety precautions:

- Do not use in or near a bathtub, sink, swimming pool, wet basement, or other water.
- Do not use this or any cordless telephone in the vicinity of a gas leak.
- Do not use in environments subject to explosion hazards, such as auto paint shops.
- Do not use near medical equipment or if you have a pacemaker.
- Unplug from wall outlet before cleaning.
- To prevent overheating, do not block slots and openings in the cabinet or the back or bottom of equipment. Do not place equipment on beds, sofas, rugs, or other surfaces that generate fibers.
- To prevent overheating, do not place near or over a radiator or in a cabinet without proper-ventilation.
- To reduce the risk of fire, use only 26 AWG or larger UL-listed or CSA-certified Telecommunication Line Cord.
- Operate using the power source indicated on the marking label. If you are unsure about the type of power supply to your home or business, consult your power company.
- Do not place objects on the power cord. Do not step on the power cord.
- To prevent exposure to dangerous voltage, do not push objects through cabinet slots.
- To reduce the risk of electric shock, do not disassemble equipment or open parts other than specified access doors. Opening or removing parts may expose you to dangerous voltage or other risks. Incorrect reassembly can cause electric shock when

equipment is subsequently used.

- Do not overload wall outlets and extension cords.
- Unplug equipment and contact qualified service if any of the following has occurred:
 1. Power supply cord or plug has been damaged or frayed.
 2. Liquid has been spilled on or in the equipment.
 3. Equipment has been exposed to rain or water.
 4. Equipment does not work normally even when the operating instructions are followed. Adjust only those controls referred to in the operating instructions. Improper adjustment of other controls may result in damage and may require extensive work by an authorized service center.
 5. Equipment has been dropped and damaged.
 6. Equipment has exhibited a distinct change in performance.
- Do not put the handset of the telephone next to your ear when the handset is not in normal talk mode.
- Radio signals transmitted between the handset and base may cause interference with hearing aids.

WARNING

The cords contain lead, a

chemical known to the State of California to cause birth defects or other reproductive harm.

Wash hands after handling.

CAUTION

To comply with the FCC's RF exposure guidelines, place the base unit at least 8 inches from persons.

Do not clean with liquid or aerosol cleaners, household polish, chemicals, or cleaning agents. To avoid static shock, do not clean with a dry cloth. Clean with only a damp (not wet) cloth.

NOTICE

To avoid damage to the equipment, observe the following precautions:

- Do not expose to water, rain, or moisture.
- Place securely on a stable surface.
- To avoid damage during an electrical storm, equipment should be plugged into a surge protector.

BATTERY SAFETY PRECAUTIONS

WARNING

The snom m3 contains a Li-ion battery.

WARNING

Fire or injury may result if you do not observe the following safety precautions:

- For the snom m3, use only the Li-ion battery pack (3.7V,

650mAh) specified in the owner's manual.

- Do not use other batteries or conventional alkaline batteries.
- To avoid explosion, do not dispose of battery pack in a fire.
- Review battery package insert for disposal instructions. Li-ion battery must be disposed of properly and may need to be recycled. Contact your local recycling center for proper disposal methods.
- Do not open or mutilate battery pack. Released electrolyte is corrosive and may damage eyes and skin and may be toxic if swallowed.
- Battery may overheat and cause burns if placed into contact with conducting materials such as rings, bracelets, and keys.

CAUTION

Charge battery pack only in accordance with the instructions and limitations specified in the user manual.

Observe proper polarity orientation between battery pack and battery charger.

Remove battery pack if storing phone for more than 30 days. Disconnect and remove batteries before shipment. Any batteries transported with the equipment must be sepa-

ately secured and cushioned with any exposed terminals covered to prevent breakage, leakage, movement within packaging, or short circuits. Failure to follow recommendations may be against U.S. Department of Transportation (DOT), International Civil Aviation Administration (ICAO), International Air Transport Association (IATA), or International Maritime Organization (IMO) regulations.

Rechargeable Li-ion Battery Must Be Recycled or Disposed of Properly. At the end of its useful life, under various state and local laws it may be illegal to dispose of a battery into the municipal waste stream. Check with your local solid waste officials for details in your area for recycling options or proper disposal.

Please call 1-800-8BATTERY for information on how to recycle the battery.

INSTALLATION GUIDELINES

1. Follow all warnings and instructions.
2. Do not install equipment near a bath tub, sink, or shower.
3. Operate the equipment using only the power source indicated on the marking label. If you are unsure of the power supply to your home or business, consult with your power company.
4. To avoid interference to nearby appliances, do not place base of the phone on

- or near a television, VCR, or microwave oven.
5. Do not expose the equipment to direct sunlight.
 6. Do not place equipment on an unstable cart, stand, or table.
 7. Adjust only those controls referred to in the operating instructions. Improper adjustment of other controls may result in damage and may require extensive work to restore equipment to normal operation.
 8. The equipment may get warm when batteries are being charged. To avoid damage, it is recommended that the product not be placed on antique or veneered wood.
 9. The location of the base unit of the phone should be close to a phone jack, a personal computer, and a continuous power outlet (an AC outlet that does not have a switch to interrupt power).
 10. Keep base and handset away from sources of electrical noise such as motors or fluorescent lighting.

FCC AND OTHER INFORMATION

This equipment complies with Parts 68 of the FCC rules and the requirements adopted by the Administrative Council for Terminal Attachments (ACTA).

This device complies with part 15 of the FCC rules. Operation is subject to the following two conditions: (1) This device may

not cause harmful interference, and (2) This device must accept any interference received, including interference that may cause undesired operation. Privacy of communications may not be ensured when using this phone.

These limits are designed to provide reasonable protection against harmful interference in a residential installation. This equipment generates, uses and can radiate radio frequency energy and, if not installed and used in accordance with the instructions, may cause harmful interference to radio communications.

However, there is no guarantee that interference will not occur in a particular installation. If this equipment does cause harmful interference to radio or television reception, which can be determined by turning the equipment off and on, the user is encouraged to try and correct the interference by one or more of the following measures:

- Reorient or relocate the receiving antenna.
- Increase the separation between the equipment and receiver.
- Connect the equipment into an outlet or on a circuit different from that to which the receiver is connected.
- Consult the dealer or an experienced radio/TV technician for help.

FCC RF exposure warning

To insure the safety of users, the FCC has established criteria for the amount of radio frequency energy various products may produce depending on their intended usage. This product has been tested and found to comply with the FCC's exposure criteria. For body worn operation, the FCC RF exposure guidelines were also met when used with the accessories supplied or designed for this product. Use of other accessories may not ensure compliance with FCC RF exposure guidelines and should be avoided.

Caution: To maintain compliance with the FCC's RF exposure guidelines, the internal antennas used for this mobile transmitter (Base unit) must provide a separation distance of at least 20 cm from all persons. Base and Handset must not be co-located or operating in conjunction with any other antenna or transmitter.

Caution: Any changes or modifications not expressly approved by the party responsible for compliance could void the user's authority to operate this device.

Hearing aid compatibility

This equipment is hearing aid compatible as defined by the FCC in 47 CFR Section 68.316.

Health and safety information FCC

Exposure to Radio Frequency

(RF) Signals

Your wireless phone is a radio transmitter and receiver. It is designed and manufactured not to exceed the emission limits for exposure to radio frequency (RF) energy set by the Federal Communications Commission of the U.S. Government. These limits are part of comprehensive guidelines and establish permitted levels of RF energy for the general population. The guidelines are based on the safety standards previously set by both U.S. and international standards bodies:

This EUT has been shown to be capable of compliance for localized specific absorption rate (SAR) for uncontrolled environment/general population exposure limits specified in ANSI/IEEE Std. C95.1-1992 and had been tested in accordance with the measurement procedures specified in FCC/OET Bulletin 65 Supplement C (2001) and IEEE Std. 1528-2003 December 2003).

The standards include a substantial safety margin designed to assure the safety of all persons, regardless of age and health. The exposure standard for wireless mobile phones employs a unit of measurement known as the Specific Absorption Rate, or SAR. The SAR limit set by the FCC and Canada is 1.6W/kg averaged over one gram of tissue. The standard incorporates a sub-

stantial margin of safety to give additional protection for the public and to account for any variations in.

RF exposure FCC

Tests for SAR are conducted using standard operating positions specified by the FCC with the phone transmitting at its highest certified power level in all tested frequency bands. Although the SAR is determined at the highest certified power level, the actual SAR level of the phone while operation can be well below the maximum value. This is because the phone is designed to operate at multiple power levels so as to use only the power required to reach the network. In general, the closer you are to a wireless base station antenna, the lower the power output.

Before a phone model is available for sale to the public, it must be tested and certified to the FCC that it does not exceed the limit established by the government-adopted requirement for safe exposure. The tests are performed in positions and locations (e.g., at the ear and worn on the body) as required by the FCC for each model. (Body-worn measurements may differ among phone models, depending upon available accessories and FCC requirements). The highest SAR value for this phone when tested for use at the ear is 0.043 W/kg, and when worn on the body is 0.015 W/kg

for 1.5cm distance. (Body worn measurements differ among phones depending upon available accessories and the FCC requirements.) While there may be differences between the SAR levels of various phones and at various positions, they all meet the government requirement for safe exposure.

For body worn operation, to maintain compliance with FCC RF exposure guidelines, use only accessories that contain no metallic components and provide a separation distance of 15mm (0.6 inches) to the body. Use of other accessories may violate FCC RF exposure guidelines and should be avoided.

Cordless telephone privacy

Cordless telephones are radio devices. Communications between the handset and base of your cordless telephone are accomplished by means of radio waves which are broadcast over the open airways. Because of the inherent physical properties of radio waves, your communications can be received by radio receiving devices other than your own cordless telephone unit. Consequently, any communications using your cordless telephone may not be private.

Programming and testing of emergency numbers

If this product has memory dialing locations, you may choose to store police, fire department and emergency medical service

telephone numbers in these locations. If you do, please keep three things in mind:

1. It is recommended that you also write the telephone number on the directory card, so that you can still dial the emergency number manually if the memory dialing feature doesn't work.
2. This feature is provided only as a convenience, and the manufacturer assumes no responsibility for customer reliance upon the memory feature.
3. Testing the emergency telephone numbers you have stored is not recommended. However, if you do make a call to an emergency number:
 - You must remain on the line and briefly explain the reason for the call before hanging up.
 - Programming/testing of emergency numbers should be performed during off-peak hours, such as in the early morning or late evening, when the emergency services tend to be less busy.

Emergency calling service (i.e., 911, 112, 999, etc.) with VoIP typically functions the same as that of traditional phone service companies. However, you are strongly advised to consult your VoIP provider to ensure that emergency service via VoIP is available in your area. In addition, you will likely be asked to register your physical address with your VoIP service provider to ensure that an emergency

response team is able to locate the origin of the emergency call. Also note that it may take several days for the registration of your address to take effect.

In order to better ensure your safety, please be aware of certain circumstances in which emergency calling service may be either unavailable or limited in comparison to traditional emergency calling services.

During an electrical power outage, an internet service outage, or a service disruption due to non-payment, your emergency calling service may not function properly.

If at any point in time your broadband phone or adapter fails, emergency calling service may not function properly.

The relocation of your snom m3 Gateway to a physical address other than that provided upon signup, or the use of a number outside of your normal area code or exchange may cause incorrect emergency calling information to be provided to your local emergency response center.

Please contact your VoIP service provider for more information.

ONE YEAR LIMITED WARRANTY
SNOM TECHNOLOGY AG,
("snom") extends the following limited warranty for its snom m3

product. snom's warranty obligations are limited to the specific terms set forth below:

One Year Limited Warranty.

snom warrants to the original retail purchaser ("you") that the snom m3 product will be free from defects in materials and workmanship for a period of one (1) year from the date of your original purchase (the "Warranty Period"), subject to specific exclusions, identified below.

What Are The Limits Of snom's Obligations And Liabilities under this Warranty? EXCEPT FOR THE EXPRESS LIMITED WARRANTY SNOM HAS PROVIDED ABOVE, YOU TAKE THE PRODUCT "AS IS." SNOM MAKES NO OTHER WARRANTY OR REPRESENTATION CONCERNING THE PRODUCT, AND EXPRESSLY DISCLAIMS ALL OTHER WARRANTIES AND CONDITIONS, EXPRESS OR IMPLIED, STATUTORY OR OTHERWISE, OF WHATEVER KIND OR NATURE, INCLUDING BUT NOT LIMITED TO ANY AND ALL IMPLIED WARRANTIES, INCLUDING IMPLIED WARRANTIES OF MERCHANTABILITY AND FITNESS FOR A PARTICULAR PURPOSE. IF SNOM CANNOT LAWFULLY DISCLAIM OR EXCLUDE IMPLIED WARRANTIES UNDER APPLICABLE LAW, THEN TO THE MAXIMUM EXTENT POSSIBLE THE DURATION OF SUCH IMPLIED WARRANTIES

SHALL EXPIRE ON EXPIRATION OF THE WARRANTY PERIOD. THE REMEDIES SET OUT BELOW ARE YOUR EXCLUSIVE REMEDIES, AND SNOM SHALL NOT BE LIABLE FOR ANY DAMAGES OF ANY KIND, INCLUDING (i) INCIDENTAL, SPECIAL, PUNITIVE, CONSEQUENTIAL, AND SIMILAR DAMAGES, (ii) ANY LOSS OF ANTICIPATED PROFITS OR BENEFITS, (iii) DAMAGES ARISING FROM ANY TORT (INCLUDING NEGLIGENCE OR GROSS NEGLIGENCE) OR FAULT COMMITTED BY SNOM, ITS AGENTS OR EMPLOYEES, OR (iv) ANY OTHER DAMAGE, INCLUDING DAMAGE RESULTING (a) FROM THE PURCHASE, USE, OR MISUSE OF THE PRODUCT, (b) FROM ANY INABILITY TO USE THE PRODUCT OR OTHER ASSOCIATED EQUIPMENT, (c) FROM LOSS OF DATA OR DATA CONFIDENTIALITY ASSOCIATED WITH THE PRODUCT, OR (d) FROM THE COST OF SUBSTITUTE EQUIPMENT.

Some States do not allow limitations on how long an implied warranty lasts, and do not allow the exclusion or limitation of incidental or consequential damages, so the above limitations or exclusions may not apply to you.

What Specifically Does this Warranty Include, and What Does it Exclude? This limited warranty covers all materials and all workmanship embodied in the snom m3 product, with

the exception of damage or defects in (i) the product's battery, (ii) the product's antenna, (iii) data stored on the product that may be lost or corrupted, or (iv) cosmetic damage to the product, that does not affect the product's functionality (the "Excluded Items"). snom will not provide warranty service for Excluded Items.

This Limited Warranty also does not apply to hardware or software products that do not bear the "snom" brand, even if these non-snom products are packaged or sold with the snom m3 product. Please review documentation for these non-snom products, as they may be covered by their own, separate warranties.

Who Enjoys The snom m3 Product Warranty?

snom extends this warranty only to you, the original retail purchaser of the snom m3 product. If you transfer ownership of the product to someone else, the limitations set out above will continue to apply, but snom will not provide warranty service to the new owner of the product.

What Will snom Do If The Product Presents A Defect?

If a defect arises and you submit a valid claim to snom within the Warranty Period, then snom, at its option, will either (1) repair the snom m3 product at no charge, using new or refurbished replacement parts,

(2) exchange the snom m3 product with a product that is new (or that has been manufactured from new or serviceable used parts) and that is at least functionally equivalent to your original snom m3 product, or (3) refund to you the purchase price of your snom m3 product.

Will This Warranty Apply To Replacement Parts?

If snom repairs or replaces your product, snom warrants the replacement products or parts against defects in materials and workmanship for that period of time (a) commencing on the date of the replacement or repair and (b) ending either ninety (90) days thereafter or on the expiration date of the Warranty Period on the original product, whichever provides you with longer warranty coverage. When snom replaces a product or part, the replacement item becomes your property, while the replaced item becomes snom's property. When a refund is given, your product becomes snom's property.

What Steps Should be Taken To Obtain Warranty Service?

If, after following the instructions in the user's manual you are certain that the Product is defective, please take the following steps:

1. Contact snom at the number below (during the hours listed) to receive a Return Authorization Number (RA Number).

2. Disconnect the battery from the product.
3. Pack the product carefully (preferably in its original packaging), and separately secure the battery in its own separate packaging within the shipping carton.
4. Include in your shipping carton all parts, accessories, manuals, and other materials originally packaged with the product.
5. Include in the shipping carton a copy of the original sales receipt or other evidence of the date of original purchase.
6. Include in the shipping carton a note (i) that describes the defect that has caused you to return the product, and (ii) that includes a day-time phone number where you can be reached.
7. Clearly write the RA Number you received on the outside of the shipping carton.
8. At your option, either insure the shipment to snom, or accept the risk if the product is lost or damaged in shipment.
9. Ship the carton containing the materials you have collected, freight prepaid and by traceable means, to snom Certified Partner.

What about Data Stored on My snom m3 Product? snom is not responsible for lost or corrupted data. Before you replace parts or return your snom m3 product for warranty service, make sure to retain a copy of any data stored

on the device. You should also remove any confidential or sensitive information stored on the product. This Limited Warranty does not cover the recovery, safeguarding, or reinstallation of programs, data, ringtones, or other information you may store on your snom m3 product.

If the Product is Damaged through Misuse, Will the Warranty Still Apply? snom's Limited Warranty does not apply to damage that is caused: (a) by accident, abuse, misuse, or misapplication of the product; (b) by product installation or programming that does not comply with instructions provided in the owner's manual; (c) by service performed by anyone other than an authorized snom service center (acting in the course fulfilling obligations under this Limited Warranty); (d) by use in conjunction with equipment, parts, conversion kits, subassemblies, or systems not manufactured by, or not approved in writing by snom; or (e) where the snom m3 product's warranty/quality stickers, product serial numbers, identification plates, or electronic serial numbers have been removed, altered or rendered illegible.

Does this Warranty Apply Outside the United States? This warranty is void outside the United States of America and Puerto Rico.

Effect of Warranty. This warranty gives you specific legal

rights, and you may also have other rights which vary from State to State.

No Modifications. No snom reseller, agent, or employee is authorized to make any modification, extension, or addition to this Limited Warranty. If you receive retailer advertising, statements, or other information that conflicts with this Limited Warranty, whether oral or written, you should not rely on such statements.

Connection between Product Pricing and Limited Warranty. This Limited Warranty allocates risk of product failure between snom and you, and snom's pricing of the snom m3 product reflects this allocation of risk and the limitations of liability contained in this Limited Warranty.

Effect of Headings. snom has provided bolded headings in the provisions of this Limited Warranty for convenience only, and these headings shall have no legal effect.

SAFETY INFORMATION & WARRANTY

AUSTRALIA

Intended Use

This telephone is designed for telephoning within the Internet. Any other use is considered unintended use. Unauthorised modifications or reconstruction not described in this manual are not permitted.

Safety information

General

- Only use the power supply included with the product. Using an unauthorised power supply will invalidate the product guarantee and may damage the telephone.
- For the snom m3 use only the Li-ion battery pack specified in the owner's manual (3.7V, 650mAh). Never use other batteries or conventional alkaline batteries.
- Even though the key lock is switched on, it is still possible to make emergency calls (see instructions for details).
- Do not open the handset (other than to change batteries) or base station. This could expose you to high voltages or other risks.
- Radio signals transmitted between the handset and base may cause interference with hearing aids.
- This product should not be used near emergency/intensive care medical equipment

- and should not be used by people with pacemakers.
- Do not install the base in bathrooms or shower rooms. The handset and base are not watertight.
- Do not use the telephone in environments subject to explosion hazard (e.g. auto paint shops).

Cleaning

- Simply clean the handset and base station with a damp (not wet) cloth, or an anti-static wipe.
- Never use household polish, as this will damage the product.
- Never use a dry cloth as this may cause a static shock.

Environmental

- Do not expose the product to direct sunlight.
- The product may heat up when the batteries are being charged. This is normal. However, we recommend that you do not place the product on antique/veneered wood to avoid damage.
- Do not stand your product on carpets or other surfaces which generate fibres, or place it in locations preventing the free flow of air over its surface.
- Do not submerge any part of your product in water and do not use it in damp or humid conditions, such as bathrooms.
- Do not expose your product to fire, explosive or other haz-

ardous conditions.

- There is a slight chance that your product could be damaged by a thunder storm. We recommend that you unplug the power and telephone line cord and switch off your computer during a thunder storm.

Limited Warranty

This limited warranty (hereinafter the Warranty) is valid after the Warranty) is valid for the products Cordless snom m3 and snom m3 handset and original accessories thereof (hereinafter the Product). The Warranty is valid only in the country in which the product was originally purchased.

- The Warranty covers only manufacturing defects, and only insofar as the Product has been used and stored in accordance with the instructions set out in the user guide.
- The Warranty is issued by the retailer from whom the Product was originally purchased to the end purchaser of the Product (hereinafter the Customer).
- In accordance with the Warranty, the Customer has a sole claim to demand that the Product be repaired/replaced and may not in accordance with the provisions of the Warranty assert further claims against the manufacturer/retailer for indirect loss, including but not limited to loss of data or loss of profit.
- The warranty period runs for

12 months from the day on which the Customer originally purchased the Product from a retailer. Subsequent changes of ownership do not extend the warranty period.

- The Warranty is valid solely on the condition that the Product is taken to a retailer within the warranty period. In the event of a fault or defect in the Product, it must be taken to a retailer in the country in which the Product was purchased. Products are repaired or exchanged at the retailer's own discretion. The warranty period is not extended for a repaired or replaced Product. Exchanged parts are the property of the retailer/manufacturer.
- The Warranty is valid solely on the condition that the original proof of purchase issued to the original purchaser is presented with the Product.

The Warranty is not valid

- if the Product has been opened or repair attempted by a person other than a retailer,
- if the fault with the Product is due to general wear, incorrect use or storage, including use or storage not conforming to the instructions set out in the user guide or faults caused by poor maintenance of the Product,
- if the fault is the result of the Product not being used for its intended purpose,
- if the fault is due to external causes such as but not

limited to rough handling or misadventure,

- if the fault is caused by the use of accessories or other peripheral units which are not original accessories intended for use with the Product,
- if the fault is due to a break in the network or power supply,
- if the fault is due to the fact that the battery has short circuited or has been forced open or an attempt made to modify it, or the battery has been used in equipment other than for which it is intended,
- if the software in the Product needs to be upgraded due to changes in the network. In addition to his statutory rights and those set out above, the Customer has no other basis for a claim.

Amendments or additions to the Warranty are only valid with the written consent of the retailer.

Warning

- Warning – This telephone will not operate during loss of mains power.
- Warning – Due to possibility of ignition hazard this telephone must be switched off in areas of potentially explosive atmospheres, such as chemical/fuel storage areas or blasting operations.
- Warning – Only use an A-tick approved headset with this device.

NEW ZEALAND

Intended Use

This telephone is designed for telephoning within the Internet. Any other use is considered unintended use. Unauthorised modifications or reconstruction not described in this manual are not permitted.

Safety information

General

- Only use the power supply included with the product. Using an unauthorised power supply will invalidate the product guarantee and may damage the telephone.
 - For the snom m3 use only the Li-ion battery pack specified in the owner's manual. Never use other batteries or conventional alkaline batteries.
 - Even though the key lock is switched on, it is still possible to make emergency calls (see instructions for details).
 - Do not open the handset (other than to change batteries) or base station. This could expose you to high voltages or other risks.
 - Radio signals transmitted between the handset and base may cause interference with hearing aids.
 - This product should not be used near emergency/intensive care medical equipment and should not be used by people with pacemakers.
- Do not install the base in bathrooms or shower rooms. The handset and base are not watertight.
 - Do not use the telephone in environments subject to explosion hazard (e.g. auto paint shops).

Cleaning

- Simply clean the handset and base station with a damp (not wet) cloth, or an anti-static wipe.
- Never use household polish, as this will damage the product.
- Never use a dry cloth as this may cause a static shock.

Environmental

- Do not expose the product to direct sunlight.
- The product may heat up when the batteries are being charged. This is normal. However, we recommend that you do not place the product on antique/veneered wood to avoid damage.
- Do not stand your product on carpets or other surfaces which generate fibres, or place it in locations preventing the free flow of air over its surface.
- Do not submerge any part of your product in water and do not use it in damp or humid conditions, such as bathrooms.
- Do not expose your product to fire, explosive or other hazardous conditions.
- There is a slight chance that

your product could be damaged by a thunder storm. We recommend that you unplug the power and telephone line cord and switch off your computer during a thunder storm.

Limited Warranty

This limited warranty (hereinafter the Warranty) is valid for the products snom m3 and snom m3 handset and original accessories thereof (hereinafter the Product). The Warranty is valid only in the country in which the product was originally purchased.

- The Warranty covers only manufacturing defects, and only insofar as the Product has been used and stored in accordance with the instructions set out in the user guide.
- The Warranty is issued by the retailer from whom the Product was originally purchased to the end purchaser of the Product (hereinafter the Customer).
- In accordance with the Warranty, the Customer has a sole claim to demand that the Product be repaired/replaced and may not in accordance with the provisions of the Warranty assert further claims against the manufacturer/retailer for indirect loss, including but not limited to loss of data or loss of profit.
- The warranty period runs for 24 months from the day on which the Customer originally purchased the Product from a

retailer. Subsequent change-of ownership do not extend the warranty period.

- The Warranty is valid solely on the condition that the Product is taken to a retailer within the warranty period. In the event of a fault or defect in the Product, it must be taken to a retailer in the country in which the Product was purchased. Products are repaired or exchanged at the retailer's own discretion. The warranty period is not extended for a repaired or replaced Product. Exchanged parts are the property of the retailer/manufacturer.
- The Warranty is valid solely on the condition that the original proof of purchase issued to the original purchaser is presented with the Product.

The Warranty is not valid

- if the Product has been opened or repair attempted by a person other than a retailer,
- if the fault with the Product is due to general wear, incorrect use or storage, including use or storage not conforming to the instructions set out in the user guide or faults caused by poor maintenance of the Product,
- if the fault is the result of the Product not being used for its intended purpose,
- if the fault is due to external causes such as but not limited to rough handling or misadventure,
- if the fault is caused by the

use of accessories or other peripheral units which are not original accessories intended for use with the Product,

- if the fault is due to a break in the network or power supply,
- if the fault is due to the fact that the battery has short circuited or has been forced open or an attempt made to modify it, or the battery has been used in equipment other than for which it is intended,
- if the software in the Product needs to be upgraded due to changes in the network. In addition to his statutory rights and those set out above, the Customer has no other basis for a claim.

Amendments or additions to the Warranty are only valid with the written consent of the retailer.

